



**Portability · Simplicity · Flexibility**

## **User Guide**

**MA-202 / ACT-202T**

**PERSONAL WIRELESS PUBLIC ADDRESS SYSTEM**



**MIPRO** MIPRO Electronics Co., Ltd.

Headquarters: 814 Pei-Kang Road, Chiayi, 60096, Taiwan.

Web: [www.mipro.com.tw](http://www.mipro.com.tw)

E-mail: [mipro@mipro.com.tw](mailto:mipro@mipro.com.tw)



## IMPORTANT SAFETY INSTRUCTIONS

1. Read these instructions.
2. Keep these instructions.
3. Heed all warnings.
4. Follow all instructions.
5. Do not use this apparatus near water.
6. Clean only with a dry cloth.
7. Do not block any ventilation openings. Install in accordance with the manufacturer's instructions.
8. Do not install near any heat sources such as radiators, heat registers, stoves, or other apparatus (including amplifiers) that produce heat.
9. Do not defeat the safety purpose of the polarised or ground plug: A polarised plug has two blades with one wider than the other. The wide blade is provided for your safety. When the provided plug does not fit into your outlet, consult an electrician for replacement of the obsolete outlet.
10. Protect the power cord from being walked on or pinched particularly at plug, convenience receptacles, and the point where they exit from the apparatus.
11. Only use attachments/accessories specified by the manufacturer.
12. Use only with a cart, stand, tripod, bracket, or table specified by the manufacturer, or sold with the apparatus. When a cart is used, use caution when moving the cart/apparatus combination to avoid injury from tip-over.
13. Unplug this apparatus during lightning storms or when unused for long periods of time.
14. Refer all servicing to qualified service personnel. Servicing is required when the apparatus has been damaged in any way, such as power-supply cord or plug is damaged, liquid has been spilled or objects have fallen into the apparatus, the apparatus has been exposed to rain or moisture, does not operate normally, or has been dropped.
15. To reduce the risk of fire or electric shock, do not expose this apparatus to rain or moisture.
16. Apparatus should not be exposed to dripping or splashing and no objects filled with liquids, should be placed on the apparatus.
17. Use only with the battery which specified by manufacturer.
18. The power supply cord set is to be the mains disconnected device.



## WARNING

1. **FOR OUTDOOR USE:**  
To reduce the risk of fire or electric shock, do not expose this apparatus to rain or moisture.
2. **UNDER WET LOCATION:**  
Apparatus should not be exposed to dripping or splashing and no objects filled with liquids, such as vases should be placed on the apparatus.
3. **SERVICE INSTRUCTIONS:**  
CAUTION - These servicing instructions are for use by qualified service personnel only. To reduce the risk of electric shock, do not perform any servicing other than that contained in the operating instructions unless you are qualified to do so.

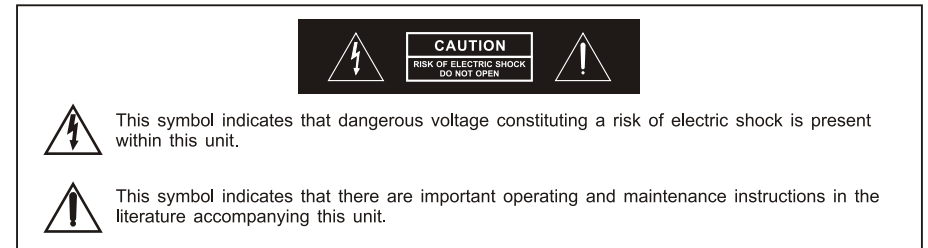

## FC & IC - ID

THIS DEVICE COMPLIES WITH PART 15 OF THE FCC RULES AND RSS-123 ISSUE1 OF CANADA. OPERATION IS SUBJECT TO THE FOLLOWING TWO CONDITIONS:

- (1) This device may not cause interference.
- (2) This device must accept any interference, including interference that may cause undesired operation of the device. This equipment complies with FCC RF radiation exposure limits set forth for an uncontrolled environment.

## Disposal

Dispose of any unusable devices or batteries responsibly and in accordance with any applicable regulations.



2005-08-13

Disposing of used batteries with domestic waste is to be avoided!

Batteries / NiCad cells often contain heavy metals such as cadmium(Cd), mercury(Hg) and lead(Pb) that makes them unsuitable for disposal with domestic waste. You may return spent batteries/ accumulators free of charge to recycling centres or anywhere else batteries/accumulators are sold.

By doing so, you contribute to the conservation of our environment!

**Personal Wireless Public Address System**

1 PRODUCT OVERVIEW  
 1 KEY FEATURES AND BENEFITS  
 2 PART NAMES AND FUNCTIONS  
 5 FRONT & BACK PANELS  
 7 DISPLAYS ALL PARAMETERS  
 9 PANEL AND FUNCTIONS OF REMOTE CONTROLLER  
 11 SET-UP RECEIVER AND TRANSMITTER FREQUENCIES  
 12 OPERATING INSTRUCTIONS  
 12 MA-202 BATTERY CHARGING PROCEDURES  
 14 MP3 PLAYER CONTROL  
 15 CONNECTION TO EXTERNAL AUDIO SOURCES  
 16 REPLACING THE RECHARGEABLE BATTERY  
 17 USB DRIVE OPERATION  
 18 OPERATING INSTRUCTIONS  
 19 TRANSMITTER MICROPHONE BATTERY CHARGING PROCEDURES  
 20 TROUBLESHOOTING-PORTABLE PUBLIC ADDRESS  
 21 TROUBLESHOOTING-WIRELESS MICROPHONE SYSTEMS  
 22 FAQ - PORTABLE PA  
 22 FAQ - RECHARGEABLE BATTERY  
 23 RECHARGEABLE BATTERY GUIDE  
 24 SPECIFICATIONS

**MA-202 Portable System Includes**

- MA-202 Main Unit x 1
- Shoulder Strap x 1 x 1
- Power Supply / Battery Charger x 1
- AC Cord x 1
- MB-30M Rechargeable Battery or MB-25 Lithium Polymer Rechargeable Battery Module x 1
- ACT-202T Handheld Transmitter Microphone x 1
- Remote Controller x 1
- User Guide x 1

**Optional SC-20 carrying bag**



**PRODUCT OVERVIEW:**

Thank you for choosing the MIPRO MA-202 Portable Wireless Public Address System.

MIPRO is recognized worldwide as a leader in portable PA products. Its' complete line of portable PA systems are easy-to-use, powerful and functional. Before operating the unit, please read this manual thoroughly, and retain it for future references.

The MA-202 is a battery powered, wireless personal PA system. Don't be misled by the compact size of this highly efficient portable PA. Lightweight and powerful, it can be hand-carried, shoulder-strapped, set on a flat surface or mounted on a microphone stand. No other brands can match the innovative features of MIPRO's AutoScan & ACT sync technology which provide the easiest channel set-up in the industry along with reliable RF reception.

Ideal applications include school classrooms, playground duty, presentations, seminars, security and safety marshals, graveside services, auctions, tours, or any outdoor/indoor location where good quality speech announcements are a requirement.

**KEY FEATURES AND BENEFITS**

**Same impressive features as MIPRO MA-101a portable, plus:**

- Powerful 56-watt audio output with D-class amplifier and 2-way speakers.
- Fast and easy channel set-up with "AutoScan" & "ACT " technology.
- USB port and SD card reader play MP3 songs.
- LCD displays MP3 tracks and status.
- MP3 tracks can be quickly found via fast search control.
- Optional high-capacity lithium battery module.
- 8 Hours continuous operation per charge.
- A smart 4-segment ( 25 / 50 / 75 / 100% ) rechargeable battery meter.
- Built-in ACT-202T handheld transmitter charger and battery status meter.
- Built-in level control in ACT-202T allows volume adjustment wirelessly.
- Built-in ACT-202T battery charger inside the storage compartment.
- Up to 2 mics can be used simultaneously ( 1 wireless & 1 wired ).
- Separate volume controls for wireless, wired microphones and line-input.
- Line-input for an external digital audio player.
- A single wireless mic can broadcast to multiple MA-202 ( same channel ).
- Hand carry or stand mount, shoulder-carrying strap included.
- Handles crowds up to 500.

**PART NAMES AND FUNCTIONS**

**FRONT PANEL**

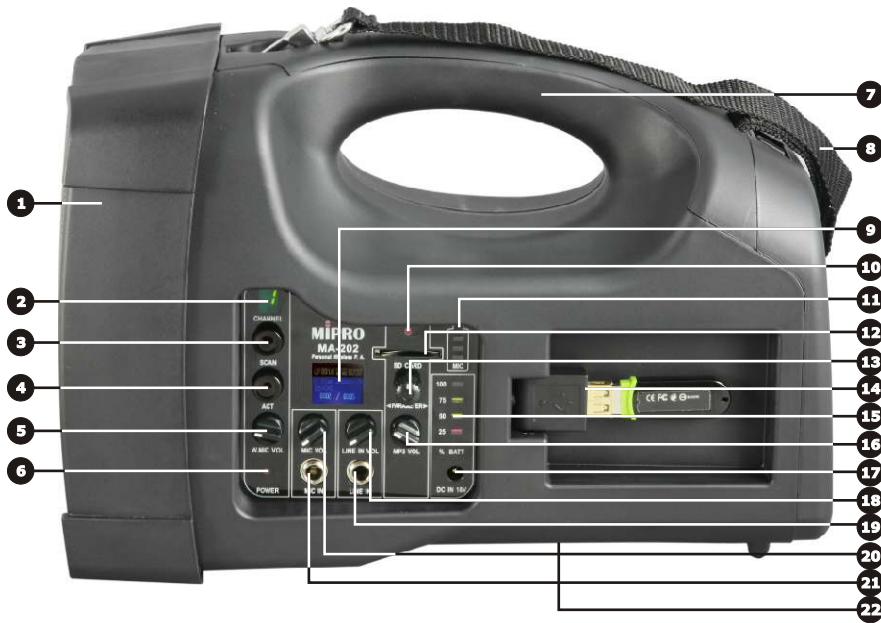

- 1 **Speakers:** 1" treble & 5" woofer, 2-way speakers.
- 2 **Channel Screen:** Displays current channel: 0 ~ F (16 total channels).
- 3 **Scan Button:** Press for an interference-free frequency,
- 4 **ACT Sync Button:** Press to synchronize the receiver and transmitter frequencies.
- 5 **Power Switch/Wireless Mic Volume Control:** Turn clockwise past the click for power-on and volume control for the wireless microphone.
- 6 **Power & RF Signal Indicator:** Red light illuminates when power is turned on to denote normal power status. Green light illuminates indicates a RF link (it is receiving signal from the wireless transmitter microphone).
- 7 **Fixed Carry Handle:** For convenient carrying by hand.
- 8 **Shoulder Strap:** Carried via the shoulder strap.
- 9 **LCD Display:** Displays current MP3 tracks, name (only English), time, and status of play/pause.
- 10 **IR Reception Port :** Receives signals from Remote Controller.
- 11 **Wireless Mic Battery Meter:** When wireless microphone is inserted for recharging, the current indicator levels are flashing to denote charged levels.

- 12 **SD Card Slot:** Supports up to 2GB capacity SD memory card with "SDHC" format. Insert the card into the slot with the label face-down. Push it down into the slot until you hear a click. To remove the card, press down on the card until a click is heard.
- 13 **MP3 Player Control:** Controls parameters for USB or SD Card media.
  - **One Right Turn:** Forward one track.
  - **One Left Turn:** Backward one track.
  - **One Right Turn & Hold:** Forward and skip every ten tracks.
  - **One Left Turn & Hold:** Backward and skip every ten tracks.
- 14 **USB Port:** Plug a Type-A USB disk to play audio files. (USB 2.0 interface)
- 15 **MA-202 Battery Meter:** Current battery level is displayed when Power Switch is turned on and/or plug into an AC outlet for recharging.
  - **Red light illuminated (25%) :** Battery is weak and charging is needed. Fully-charged takes a minimum of 3~4 hours.
  - **Green light(s) blinking:** Charging is in progress.
  - **Green lights illuminated (100%):** Battery is fully charged.

**Note:** This system is equipped with an auto cut-off charger. When the battery is weak (red light illuminates for a period of time), power will cut off automatically to avoid any damage that could be caused by a power over-drain.
- 16 **MP3 Power & Volume Control:** LCD is illuminated after the power is turned-on. Insert the USB or SD card and adjust for proper volume level.
- 17 **DC Power Input Jack:** Connects to DC 18V, 2.5A.
- 18 **Line Input Volume Control:** Volume level control for external audio signals.
- 19 **Auxiliary (Line) Input Jack:** Accepts external audio line inputs, such as CD, MP3, cassette, computer sound card, or other audio signals. Uses a 6.3mm (1/4") "phone-jack" plug.
- 20 **Wired Microphone Volume Control:** Volume control for the wired microphone.
- 21 **Microphone Input Jack:** Accepts a 6.3mm (1/4") wired dynamic microphone. (Mic Level)
- 22 **Microphone Stand Mount:** For convenient mounting on a standard microphone stand.



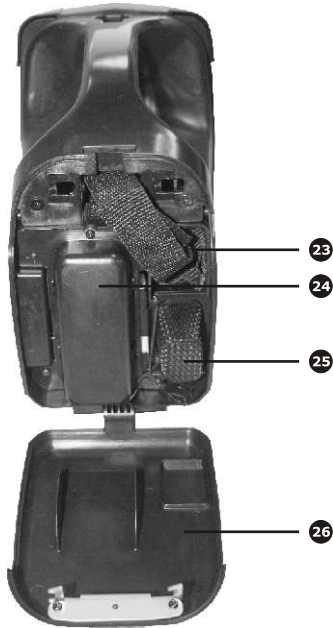

- 23 **Shoulder Straps Compartment:** Holds shoulder straps.
- 24 **Rechargeable Battery Module:** Holds either MB-30M or MB-25 battery module.
- 25 **Microphone Storage and Charger:** Holds and charges the wireless microphone automatically when stored. The LEDs stop blinking once it is fully charged.
- 26 **Compartment Door:** Protects battery, shoulder straps and wireless microphone.

**PART NAMES AND FUNCTIONS**  
**FRONT & BACK PANELS**

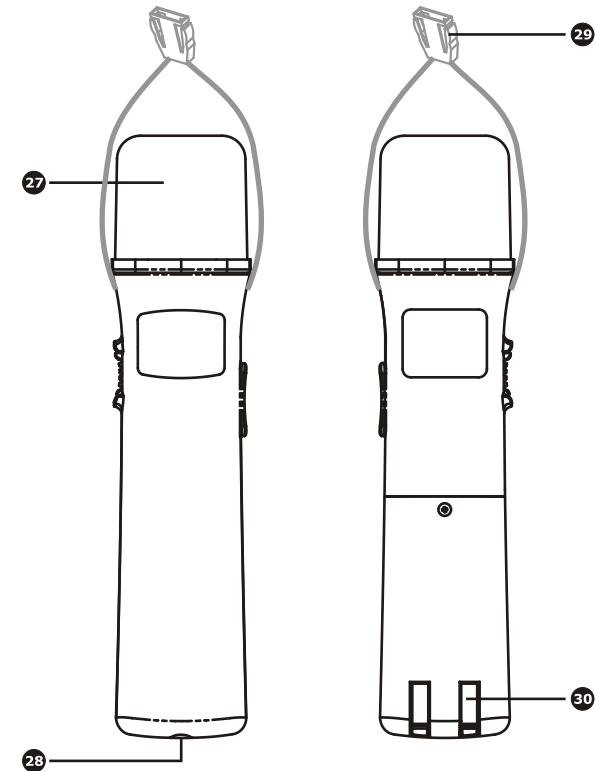

- 27 **Microphone:** Harden grill protects microphone capsule and eliminates pop and wind noises.
  - 28 **ACT IR Port:** It syncs the transmitter and receiver frequency automatically. When the ACT button of MA-202 is pressed and activated, bring the red IR port within 30cm (12") of ACT button for successful frequency synchronization.
  - 29 **Lanyard Hanger:** Secure the transmitter microphone in place with a lanyard in order to be worn around the neck for hands-free operation.
  - 30 **Contact Points:** Ensure metal contact points are properly touched inside the battery charger for re-recharging.
- Caution:** To prevent shortage, do not allow contact points to touch other metal objects.

SIDE PANELS

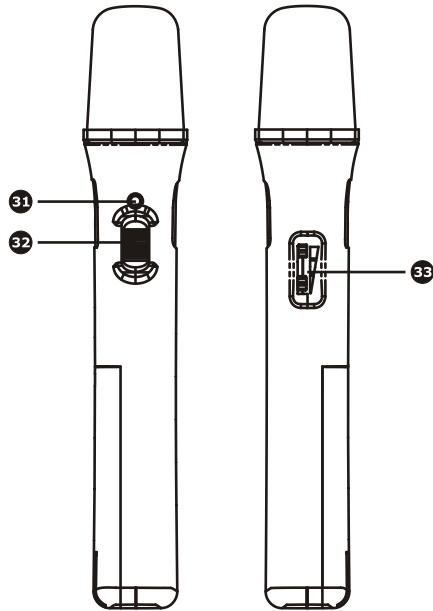

- 31 Transmitter Power Indicator:** Determines current battery power level.

  - Normal Battery:** Indicator illuminates and dims when turned on.
  - Low Battery:** Indicator stays illuminated when turned on. Recharge immediately.
  - Drained Battery:** Indicator does not illuminate when turned on. Recharge immediately.
  - No Battery or Installed Incorrectly:** Indicator does not illuminate when turned on.
  - Different Frequency Band:** Indicator flashes 4~5 times. Check to see if right frequency band is used.
- 32 Transmitter Power Switch:** Power ON to speak or amplification. Make sure transmitter is OFF position when not in use or during charging.
- 33 Volume Control:** Volume level adjustment.

Displays all Parameters

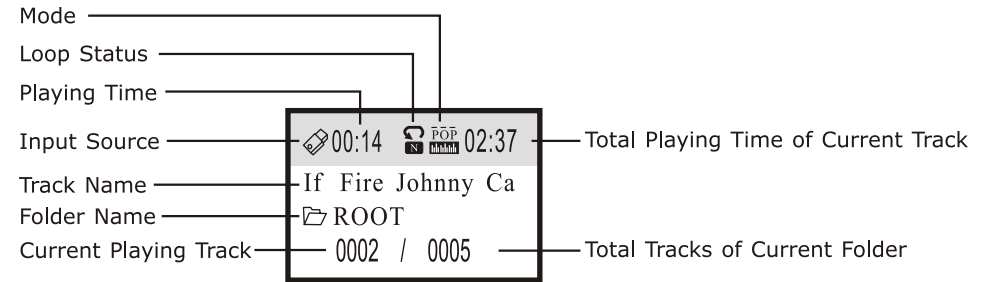

Press **13** to pause track



No input source is inserted

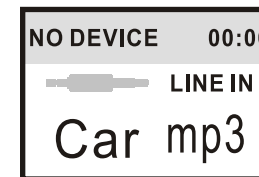

Press and hold **13** to enter function lists. Change parameters by turning right or left **13** and release when entering desired function parameter. Press **13** shortly to confirm the current/changed parameters.

### Change "Repeat" parameter

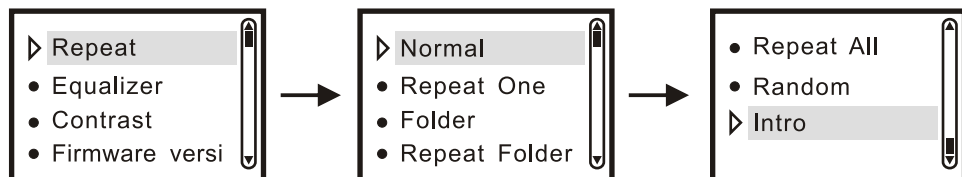

### Change "Equalizer" parameter

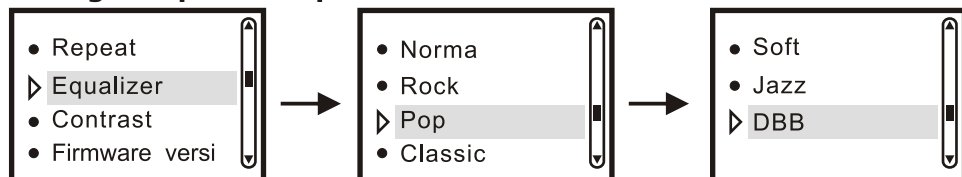

### Change "Contrast" parameter

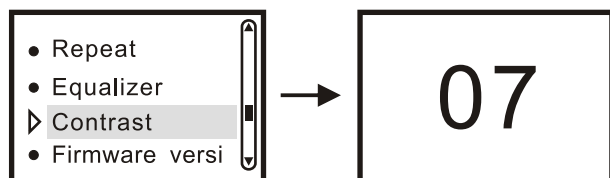

### Display software version and current time.

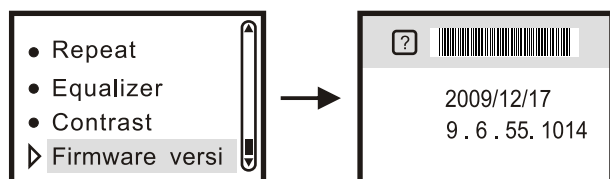

### Exit and return to play mode

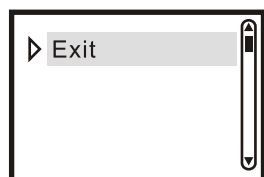

### Panel and Functions of Remote Controller

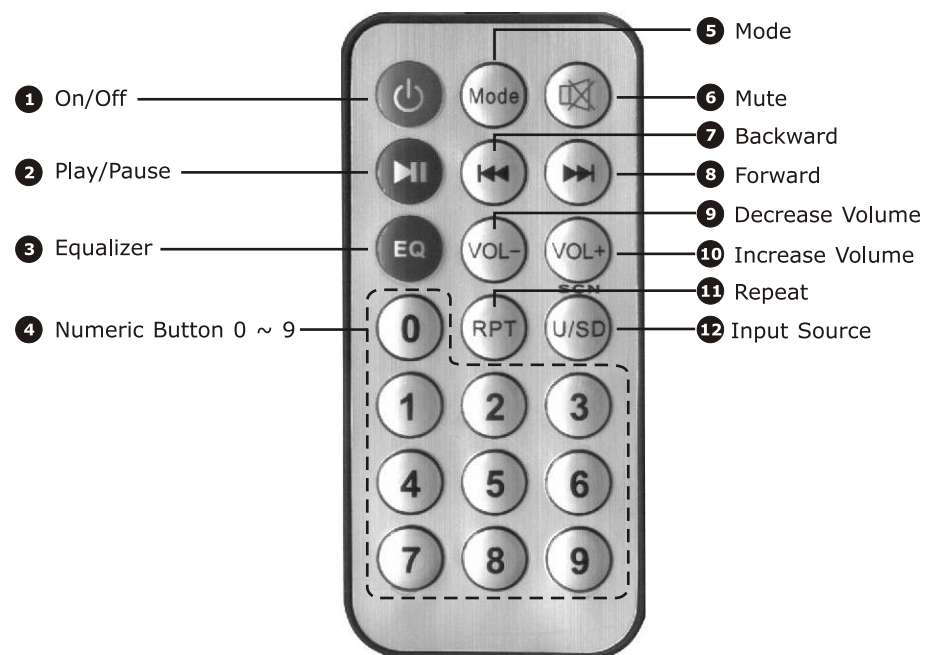

- 1 On/Off:** Power on and off.
- 2 Play/Pause:** Play and Pause Music.
- 3 Equalizer:** Press once to enter next equalizer parameter.
- 4 Numeric Button 0 ~ 9:** 10 buttons from 0 to 9. Select desired track by the listed numeric numbers.
- 5 Mode:** Select the mode for changing parameter.
- 6 Mute:** Sound is muted/Sound is unmuted.
- 7 Backward:** Back to last track.
- 8 Forward:** Move to next track.
- 9 Decrease Volume:** Decrease one volume unit when press once.
- 10 Increase Volume:** Increase one volume unit when press once.
- 11 Repeat:** Press once to enter next repeat mode.
- 12 Input Source:** Select input for USB or SD.

**Battery installation of remote controller**

1. Press and hold the tenon located on lower left-hand corner of the rear remote controller, pull out the battery set by the slot at the right.
2. Place the battery (positive electrode faces upwards) according to its correct polarity.
3. Push the battery compartment back to the fixed position.

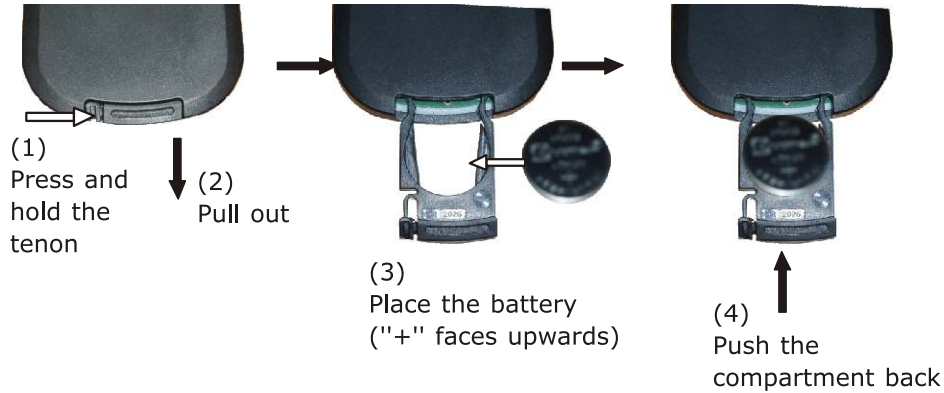

**\*\* Note :**  
The effective transmission range is 3~5 meters. Use only CR2025 3V lithium battery.

**SYSTEM SET-UP**

**SET-UP RECEIVER AND TRANSMITTER FREQUENCIES**

1. Turn "ON" the Power Switch.   
W.MIC VOL
2. The Power Indicator red light is lit.

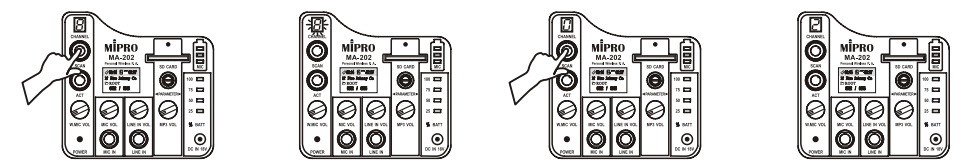

3. Press & hold "SCAN" button for 1 second
4. Existing channel blinks
5. Press & release "SCAN" button
6. New interference-free channel appears

**AUTOMATIC "TRANSMITTER" SYNC**

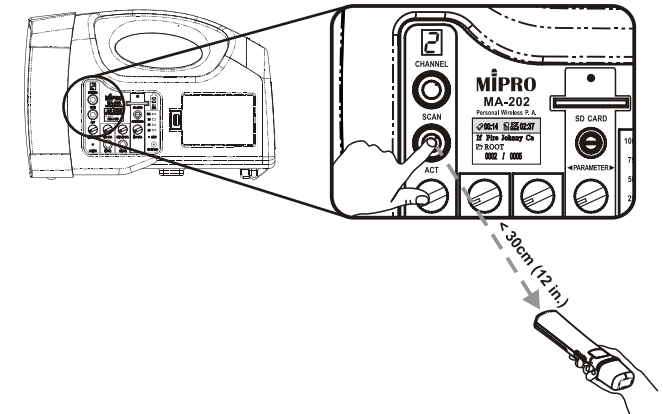

1. POWER on transmitter (ensure fresh batteries are properly installed with the correct polarity). Replace transmitter battery when LED glows red during powered-on. (glows red = low battery)
2. Locate and bring an ACT transmitter \*infrared (IR) port within 30cm (12-inch) of receiver's ACT button.
3. Press and release "ACT" button to synchronize transmitter and receiver frequencies.
4. When the frequencies are synchronized successfully the Power Indicator light will turn from red to green to indicate it is receiving RF signal from the transmitter.

**NOTE:** Receiver channel selection can be set-up manually, too.

- Press and hold 'SCAN" button for 1 second. Current channel blinks.
- During blinking, press, hold and stop "SCAN" until the desired channel.
- Repeat Automatic "Transmitter" Sync steps.

## OPERATING INSTRUCTIONS

### PERSONAL WIRELESS PA SYSTEM

- Turn on Power Switch / Volume Control ⑤ . Red light ⑥ should illuminate.
- Turn on wireless transmitter. Green light ⑥ should illuminate if there is RF link.
- Adjust volume level ⑤ clockwise to desired loudness.
- One wireless microphone can simultaneously transmit to multiple MA-202 units receiving on the same frequency for a wider and expanded coverage.
- Multiple wireless microphones of the same frequency cannot transmit to an MA-202 receiver on that same frequency. For example, if you have both a hand-held wireless microphone and a body-pack transmitter on the same frequency, be sure to switch off one of the two to avoid severe interference between them!

### MA-202 BATTERY CHARGING PROCEDURES

- Please make sure the built-in rechargeable batteries are fully charged before and after use. The battery itself will gradually self-discharge over a long period of time. Therefore, if the system will not be used for a long period of time, please make sure the batteries are fully charged before storing them properly. The Company warranty DOES NOT applies to over-discharged batteries; hence, please ensure the batteries are recharged every 3 months.
- Simply plug the connector of the supplied DC adapter to the DC 18V Power Input Jack ⑭ and plug the other end into any available AC socket.
- Battery will re-charge itself once plugged-in regardless if the system is turned on or off.
- Charging begins immediately, and will be indicated by a flashing LEDs. If the LEDs are not flashing, it may due to excessive power over-drain and it may take longer for the LEDs to flash. This is normal and not faulty. If, after a while, there is still no flashing LEDs, the rechargeable battery may be faulty.
- If a battery replacement is needed, open the battery compartment and exchange the faulty battery for a new one. Be sure to insert the battery with the right polarity connection.

- The battery is an expendable item. Under normal operation, MIPRO offers a one-year limited warranty.
- If you experience a short operating time after the batteries are fully charged, it is often an indication of aging batteries. Therefore, the rechargeable battery should be replaced as soon as possible at your earliest convenience.

### AUXILIARY INPUT

- Connect a line-level source, such as portable cassette/CD/MP3 player into the Aux input jack ⑮ .
- Turn on the PA system ⑤ and adjust volume as desired.

### INSTALLATION METHODS

**Hand Carrying:** Remove the shoulder belt ⑧ and store in the Battery Compartment ⑳ directly above the battery. Use the Fixed Handle for transport.

**Shoulder Carrying:** Remove the shoulder belt ⑧ from the Battery Compartment ⑳ and hook the connector around the rod on top of the unit, between the Fixed Handle and the Speaker.

**Mic Stand Mounting:** The MA-202 will fit directly on top of a microphone stand using the threaded mount ㉒ with no additional hardware. Simply align the hole with the protruding end of the mic stand and thread it on the stand.

### WIRED MICROPHONE INSTRUCTIONS

- Turn on Power Switch / Volume Control ⑤ . Red light ⑥ should illuminate.
- Plug a wired microphone into the Mic In Jack ㉑ . Turn on the Wired Microphone Volume Control ㉒ .
- Turn clockwise for desired loudness.
- The MA-202 allows simultaneous usage of both wired and wireless microphones.



### Audio Playing Instructions

- LCD is illuminated after the power is turned-on. Adjust for proper volume level.
- Press **13** once to pause.
- **One Right Turn 13** : Forward one track.
- **One Left Turn 13** : Backward one track.
- **One Right Turn & Hold 13** : Skips forward every ten tracks.
- **One Left Turn & Hold 13** : Skips backward every ten tracks.
- Press **13** to power-off **16** .

### MP3 PLAYER CONTROL

- **One Right Turn:** Forward one track.
- **One Left Turn:** Backward one track.
- **One Right Turn & Hold:** Skips forward every ten tracks.
- **One Left Turn & Hold:** Skips backward every ten tracks.

### CONNECTION TO EXTERNAL AUDIO SOURCES

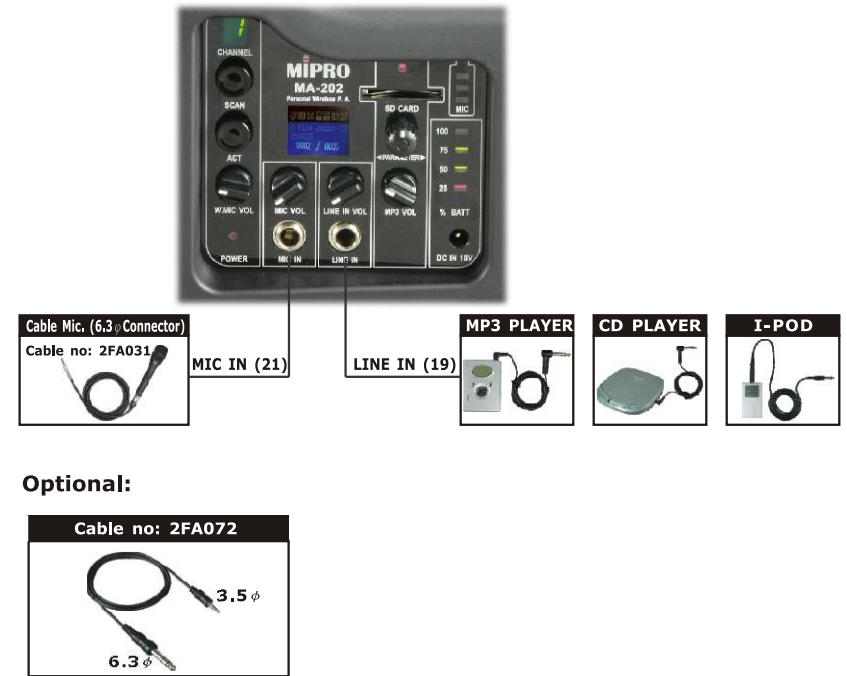

### LINE-INPUT (AUXILLARY)

- The 6.3mm (1/4") auxiliary input jack accepts an external MP3, DVD, cassette or CD players, music instruments or audio line output from another device like a computer sound card.
- Ascertain volumes of both MP3, DVD, cassette or CD players and Power Switch/Wireless Mic Volume Control are turn down before plugging into the MA-202 auxiliary input jack.
- Adjust both volumes clockwise for the desired sound levels.

### REPLACING THE RECHARGEABLE BATTERY

With proper care and charging, it is unlikely that it will be necessary to replace the MA-202 battery for some time. However, there is an access panel provided for this purpose. If extended periods of use are required without time to recharge the battery, you may wish to have a second battery fully charged and ready to install and use once the existing one is drained. The rechargeable battery is a standard 12V/2.9A gel cell or 14.8V/3A lithium polymer. Both are available from MIPRO and from its authorized distributors and dealers.

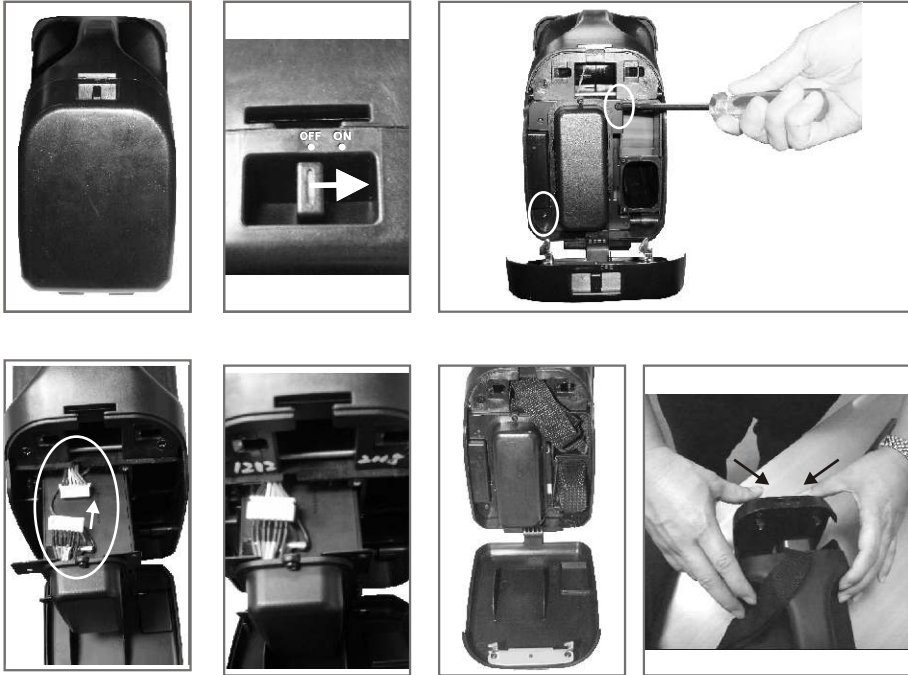

- Lay the PA system on a flat surface.
- Press the switch on the compartment door to "OPEN" position. The compartment door will now swing down on its hinge.
- Remove the two screws on the top right and bottom left. The battery module is now ready for replacement. The battery module is attached to the battery protection cover. Carefully pull out the battery and remove it completely by detaching the connecting pin.
- Ascertain the connecting pin is attached back in place before inserting the fully charged battery. Carefully slide the battery back in the slot. Fasten the two screws back in place.
- Close the battery compartment door. Ascertain the compartment door is firmly shut by pushing in gently and a click is heard.

### USB DRIVE OPERATION



Remove the protective cap



Standard USB port storage position



Pull out the USB port to a 90 degree angle



Insert a Type-A USB disk (USB 2.0 interface)



Push back the USB port into the standard position to prevent accidental issues.

**NOTE:** SD Card has playing priority over USB if both audio devices are plugged-in.

**OPERATING INSTRUCTIONS:**

**TRANSMITTER MICROPHONE**

- Turn on Power Switch 5 on MA-202. Red light illuminates on Power & RF Signal Indicator 6 to denote MA-202 power is on and charged.
- Ensure transmitter microphone is fully-charged. Turn on Transmitter Power Switch. Red light should illuminate for 1-2 seconds before it dims to denote transmitter power is on and charged.
- If there a successful RF link between the transmitter and MA-202 the Power & RF Signal Indicator will illuminate green.
- Speak into the transmitter microphone directly for amplification.

**Note:** The transmitter microphone can be connected and worn as a neck lanyard for hands-free presentation or performance. Adjustable strap for ideal length and minimizes the distance needed for optimal sound quality between the microphone and speaker's mouth. Minimize the volume to reduce chances of feedback.

**TRANSMITTER MICROPHONE BATTERY STATUS:**

**Normal or Fully Charged Battery:**

Red indicator illuminates for 1-2 seconds and dims when Transmitter Power Switch 32 is turned on.

**Low Power Battery:**

Red indicator stays illuminated when Transmitter Power Switch 32 is turned on. Re-charge soon.

**Drained Battery:**

Red indicator does not illuminate when Transmitter Power Switch 32 is turned on. Recharge immediately.

**No Battery Inside or Battery Installed Incorrectly:**

Red indicator does not illuminate when Transmitter Power Switch 32 is turned on.

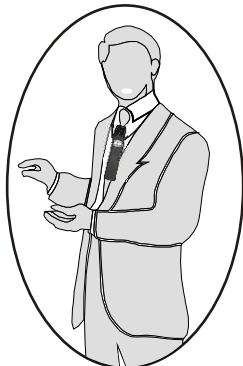

**TRANSMITTER MICROPHONE BATTERY CHARGING PROCEDURES:**

- Lay the PA system on a flat surface.
- Press the switch on the compartment door to "OPEN" position. The compartment door will now swing down on its hinge.
- Insert the bottom (metal contact points) of the transmitter microphone into the bottom slot. Charging begins immediately denote by the flashing LEDs on Wireless Mic Battery Meter 11 .
- The transmitter microphone will charge regardless which side was inserted.
- Gently close the battery compartment door. Ascertain the compartment door is firmly shut by pushing in gently and a click sound is heard.

**NOTE:**

- Charging begins automatically during storage regardless if MA-202 is turned on or off.
- Once the transmitter microphone is fully charged, the built-in charging circuitry will automatically cut-off and stop the charging. No additional power will be consumed or used.

**TROUBLESHOOTING-PORTABLE PUBLIC ADDRESS**

PROBLEM	POSSIBLE CAUSE	SOLUTION
No Sound or Faint Sound From Speaker	Volume turned down	Adjust volume
	Power switch is turned off	Turn power switch on
Power Indicator Not On	Power switch is turned off	Turn power switch on
	Rechargeable Battery is discharged	Plug into AC outlet to recharge
	Rechargeable Battery is "dead"	Replace battery and plug into AC outlet to recharge
Distorted Sound From Speaker	Volume set too high	Reduce volume
	Excessive wind noise or breath "pops"	Use windscreen on wireless & wired microphones.
	Input signal too strong	Adjust input signals
Excessive Feedback	Microphone too close or directly in front of the speaker	Move microphone away from the speaker
	Volume set too high	Reduce volume
	Microphone too far from sound source (requiring the volume to be turned up to compensate)	Speak closer to the microphone or move microphone closer to sound source
Weak, Distorted Sound. Power Indicator Flickers	Batteries level is low	Plug into AC outlet to recharge
Excessive Hum or Noise	Input Cable not shielded	Use shielded cable
Shortened Battery Life	Old or overused battery	Recharge or replace battery
	Battery is not charged for over 3~4 months	Recharge or replace battery
Battery CHARGE Indicator Not Flickering when plugged into AC Outlet	Rechargeable Battery is "dead"	Replace battery
	Battery is not charged for over 3~4 months	Recharge or replace battery
	Battery is fully charged (CHARGE indicator is lit)	N/A

**TROUBLESHOOTING-WIRELESS MICROPHONE SYSTEMS**

PROBLEM	POSSIBLE CAUSE	SOLUTION
No Sound From Speaker	Master or receiver volume turned down	Adjust volumes
	Transmitter or receiver switch is turned off	Turn transmitter or receiver switch on
	Receiver and transmitter have different frequencies	See "Set-up Receiver & Transmitter Frequencies" section
	Transmitter battery is low or no battery inside	Replace or insert new battery
Distortion or Unwanted Noise Bursts	Interference	Remove nearby sources of RF interference (computers, amplifiers, karaoke machines, digital effects, CD players, etc)
	Noise Indicator is lit	Adjust "Sensitivity" on receiver.  If problem persists, change Receiver & Transmitter frequencies.  See "Set-up Receiver & Transmitter Frequencies" section
Sound Dropouts	Out of operating range	Move transmitter closer to receiver
	Obstructions between the receiver and transmitter	Remove obstructions or reposition  Line-of-sight between receiver & transmitter
	Weak Transmitter Battery	Replace Transmitter Battery
	Interference	Change Receiver & Transmitter frequencies  See "Set-up Receiver & Transmitter Frequencies" section

## FAQ - PORTABLE PA

**Q: How to adjust for optimal sound volume?**

A: If the portable system has both Master & Microphone volumes, we recommend turning the Master volume to about 3pm (clockwise) first and about 1~2pm (clockwise) for Microphone or other volumes.

**Q: How to prevent and minimize the annoying feedback?**

- A1: Do not stand directly in front of the speakers; keep mics away from speakers.
- A2: Avoid pointing microphone towards the speakers.
- A3: The microphones should be behind the speakers wherever possible.
- A4: Locate the portable PA between the crowd and the presenters and facing the crowd.
- A5: Turn down the sound level coming out of the portable PA / speakers if necessary.
- A6: Place the speakers above the head of the crowd.

**Q: What if I need more power to cover a larger crowd?**

A: Two or more portables can be used with one wireless microphone transmitter. Ascertain that the receiver frequency in each portable coincides with the wireless microphone.

**Q: Can I play music through the systems?**

A: Yes. All MIPRO portables have auxiliary inputs (3.5mm min-jack, RCA or 1/4"phone), which will accept input from an external iPod, MP3, CD, cassette, VCR, DVD players. As well, modular CD players can be inserted into most models.

## FAQ - RECHARGEABLE BATTERY

**Q: How to Charge the Battery?**

A: Simply plug into a power outlet using the included power cable and adapter. "Flashing" LED indicates it is charging. The main power switch can be on or off position during charging. Microphones or music can be used during charging & power is on.

**Q: How to Spot System Low Battery?**

A: When Power LED is lit (MA-705 & MA-707) or Charge LED is lit (MA-101& MA-101a) or one indicator remaining in battery meter (MA-202, MA-708, MA-808). Plug into a power outlet to re-charge ASAP.

**Q: Average Life Span of Sealed Lead-Acid Rechargeable Battery?**

A: The batteries should have a life of approx. 2 years if used and maintained properly. Battery life is determined by temperature, depth and rate of discharge, and the number of charges and discharges (called cycles).

**Q: When to Replace the Battery?**

- A1: Power LED indicator is not "lit" when power on. (No battery voltage).
- A2: LED indicator or meter is not "flashing" when plugged-in.
- A3: Getting 1~2 hours operating time per charge.
- A4: When battery has been used extensively for 2~3 years or more.

## RECHARGEABLE BATTERY GUIDE

**Tips - To Prolong the Life of Rechargeable Batteries**

- Always charge the batteries before first and after use.
- Always store portable system with batteries in a fully charged condition.
- Always power off the portable system and transmitter/mic when NOT in use
- It is OK to leave the system plugged into a power outlet when not being used for a long time. The built-in automatic protection circuitry will auto shut-off when fully charged. It will not harm the system or the battery.
- Fully charge the system at least once every 3 months. Battery may not charge if not charged for a prolonged periods of time.
- Store in dry, cool place away from heat. Elevated temperature reduces longevity.
- CAUTION: DO NOT** recharge other types of batteries and connect a battery's negative terminal to another batteries positive terminal. An explosion and/or a fire could occur as a result. Use only rechargeable sealed lead-acid (gel cell) batteries.



**SPECIFICATIONS:**

AF Power Output	40W (RMS) /4Ω , 56W (MAX) /4Ω
T.H.D.	< 1%
Frequency Response	50Hz~18KHz
Speaker	1" treble and 5" woofer
Audio Inputs	Microphone & Line input. 6.3Φ(1/4") phone-jack connector. Separate volume controls.
USB & SD Card Player	MP3 and WMA media format. LCD displays current/total tracks, time, name (English only), input source, loop status, EQ, and play/pause status.
Wireless Receiver	UHF 16 switchable channels. AutoScan and ACT technology
Frequency Range	620~934MHz
Bandwidth	24MHz
Preset Channel	16 User Selectable
Antenna	Integrated
Power Supply	Built-in 12V / 2.9AH rechargeable battery or optional 16.8V / 3AH lithium & 18V DC / 100~240V AC switching power supply.
Charging & Operating Time	4 hours (automatic charging system) for up to 5 hours usage
Matching Transmitter	ACT-202T Handheld Transmitter Microphone.
Dimensions	163(W)×206(H)×306(D)mm / 6.4(W)×8.1(H)×12(D)"
Weight	MB-25 lithium: 3.1Kg / 6.8lbs (including ACT-202T) MB-30M gel cell: 4.0Kg / 9.0lbs. (including ACT-202T)
Exterior Color	Black
Approvals & Patent	New designs. Complies with worldwide telecommunication and safety regulations.
Note	<ul style="list-style-type: none"> <li>• Refer to actual product in the event of product discrepancy.</li> <li>• Varied specifications on carrier frequency range, maximum deviation and RF output power to comply with regulation of different countries.</li> </ul>